

1. Description

Geriatric lift chair RELAX provides a comfortable rest for people of advanced age, permanently residing in their own home. The chair is equipped with a dual independent drive, which provides maximum user comfort, thanks to a number of setting choices. The handset allows to adjust the chair individually to the user's needs. Thanks to the lifting function, the chair tilts forward making it easier for an elderly person to both stand up from the chair and sit down in the chair.

The set includes:

- chair with base frame,
- backrest,
- power cable with power supply,
- handset.



2. Application

The geriatric chair is designed for people:

- having problems with independent movement,
- with mobility dysfunctions and limitations,
- with weakness of the body due to advanced age.

3. Assembling, disassembling and operation

Before assembling

- Make sure that the chair will be placed on a level surface.
- Make sure there is enough space between the chair and the wall and other objects in the room.
- Remove the restraints securing the chair wires to the base frame

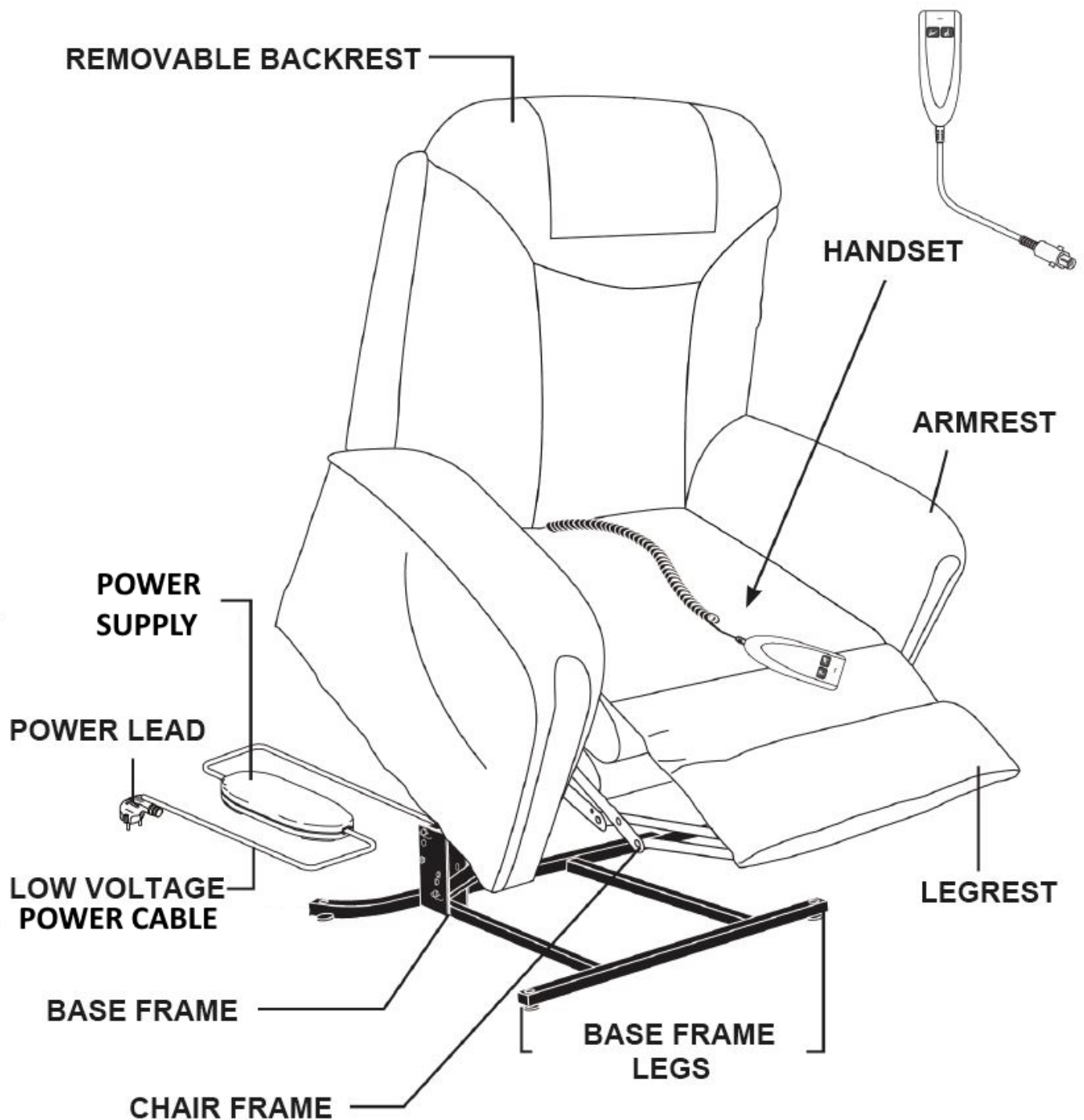

Assembling

- The chair is supplied fully assembled, except for the removable backrest.
- Connect the backrest to the seat using the two mounting rails located on both sides of the seat.
- Press down on the backrest until both mounting rails snap into place.

- Make sure the backrest is securely fastened by pulling it slightly upward. If the backrest is loose, repeat the above assembling steps.
- Using the front and rear Velcro straps, fasten the two fabric covers that connect the backrest to the seat.
- Connect the power cable to the socket located at the base frame. Lock the socket.
- Connect the handset cable to the socket located in the side pocket of the chair. Lock the socket.

Disassembling

- After unlocking the socket locks, pull out both plugs of the handset and power cables.
- Unfasten both fabric covers (front and rear Velcro).
- Using an appropriate tool, slightly bend the mounting locks of both mounting rails and slide out the backrest.

Handset operation

Button A

Downward movement of the backrest

Button B

Upward movement of the backrest

Button C

Lifting - upward movement of the entire chair until it tilts slightly to make it easier to stand up from the chair. If the footrests are raised, pressing the button at first lowers the footrests, and then lifting the chair.

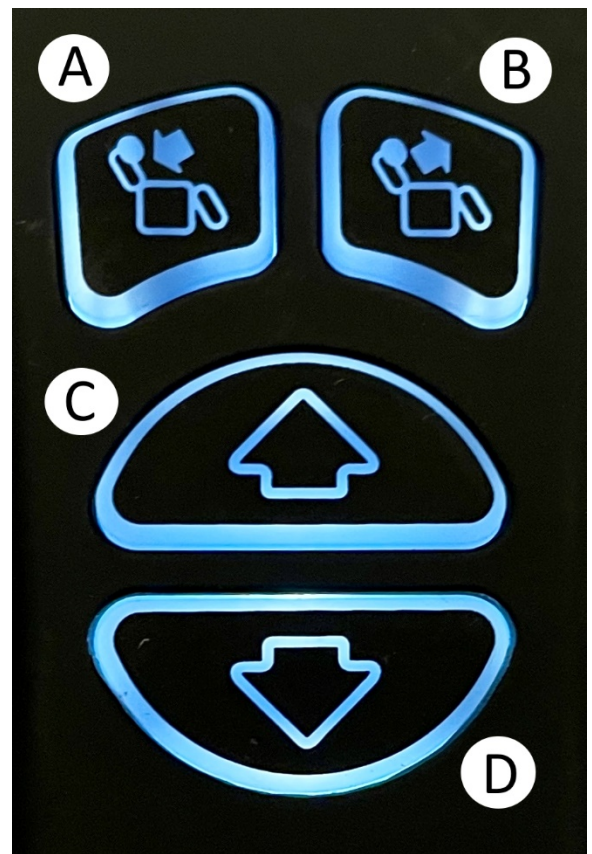

Button D

Leveling - downward movement of the entire chair.

After reaching the neutral position, further pressing the button raises the footrest.

Chair transportation

The chair is equipped with two rear transport wheels (figure below).

To move the seat, tilt the backrest slightly backward so that the chair rests on the rear wheels. Then move the chair.

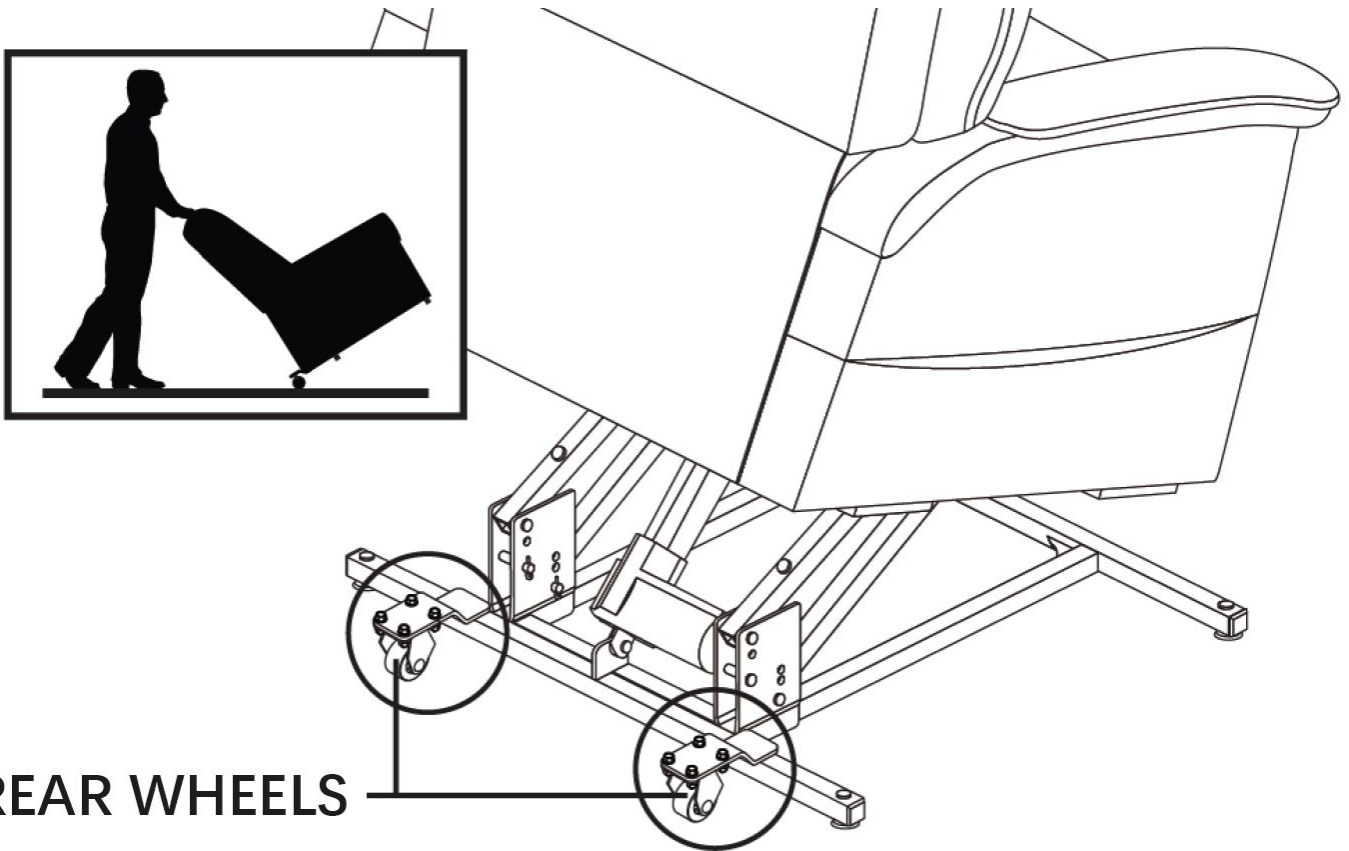

REAR WHEELS

4. Technical data

Total length (sit position)	85 cm
Total height (sit position)	109 cm
Seat depth	43 cm
Backrest height	76 cm

Seat height (sit position)	51,5 cm
Total width	80 cm
Total height	55 cm
Armrest height	12,5 cm
Total length (recline position)	159 cm
Total height (recline position)	89 cm
Total length (lifting position)	84 cm
Total height (lifting position)	129 cm
Backrest recline angle	141°
Footrest rise angle	89°
Chair lift angle	17°
Weight	43 kg
Max capacity	130 kg
Drive type	dual
Upholstery color	Mocca

5. Notes and remarks

- Chair is designed for indoor use.
- Sitting on the chair by more than one person is prohibited.
- Do not sit on the backrest, armrest or footrest of the chair.
- Keep hands and feet away from moving parts of the base frame and chair frame.

Timago International Group does not bear responsibility of improper use of the chair, failure to comply safety regulations and misuse.

6. Maintenance

Clean the upholstery with a damp cloth and then dry thoroughly. Do not use harsh disinfectants, as this risks damaging the fabric. Remove dirt from the moving parts of the base frame and chair frame.









7. Storage and transport conditions

Device should not be exposed to direct sunlight, water or moisture.

8. Warranty information

All products distributed by our company are covered by a warranty, the terms of which are described in the warranty card available on our website. Please contact the retailer from whom you purchased the product. Please, keep in mind that for warranty purposes, the proof of purchase (receipt or invoice) should be retained.

9. Labels

	Reference number		Manufacturer
	LOT number		Manufacture date
	Serial number		Medical device
	Note		Please read the instruction
	The manufacturer checked for compliance with essential medical devices requirements.		

