

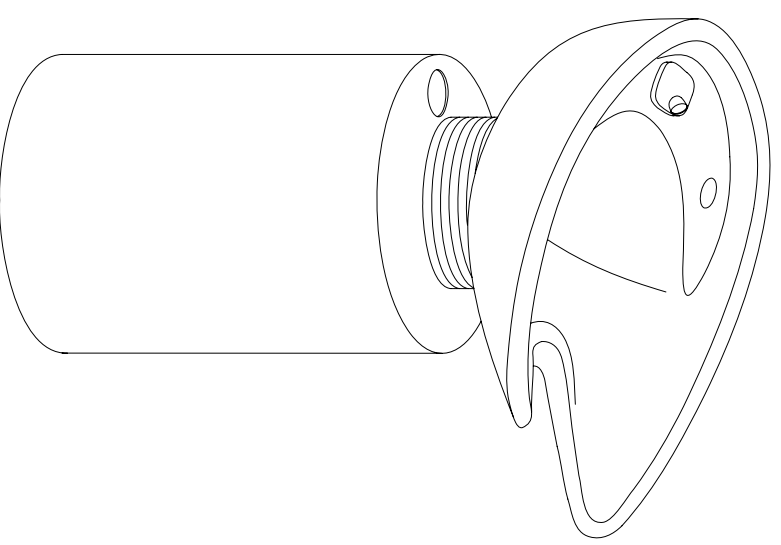

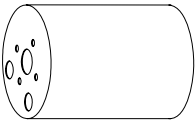

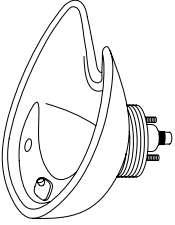

G base / SU-23B Assembly Instructions

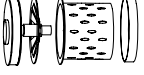

Part List

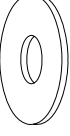
			
A.Stainless steel base 1pc	B.Bowl 1pc	C.Pipe 1pc	D.Drain 1pc
			
E.Expansion bolt 4pcs	F.Washer $\varnothing 8 \times 22$ 4pcs	G.Screw nut M8 4pcs	

Installation:

1. Open backcover on A, take handle out by releasing screws and fasten handle on outside of backcover; Align the metal bar on the bottom of A with holes on the ground, and fix E through the metal bar into ground.
2. Attach one end of C to the bottom of B and ensure they are well connected.
3. Place B on top of A, allowing C go through the centered hole on top of A, and insert the bolt of B into the small holes around centered hole, then screw G with F onto the bolt of B.
4. Place D into the centered hole on the bottom of B as shown in chart 4.
5. Make sure all the parts are securely fitted before use.

Installation

